

VARIABLE SPEED DRIVE NEO-WIFI



NEO
PATENTED

PATENTED





VS



MADE IN ITALY

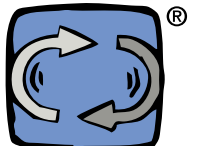

what do you want?

NEOWi-Fi



VS



NEO-WIFI tutorial



https://www.youtube.com/watch?v=hUXJ47P_Qxo&feature=youtu.be



www.motive.it

Technical specifications pag. 2-3



Examples pag. 4

Working conditions pag. 5



Working conditions pag. 6-7



Motors that can be connected
Motor assembly pag. 8

Mechanical assembly
Keypad assembly pag. 9



Mechanical assembly
Keypad assembly
BLOCK pag. 10

ATEX V.F.Drives pag. 11



Electrical assembly

Connection of the external
devices pag. 12-13



Programming

Keypad-inverter communication pag. 14

Keypad buttons and led pag. 15



Programming

Functions menu
Advanced functions menu pag. 16-17



Smartphone/Tablet/PLC/PC
Declaration of conformity pag. 18

Dimensions pag. 19



Terms of sale and guarantee pag. 20



TECHNICAL SPECIFICATIONS

The purpose of an integrated motor-inverter is to save time and reduce costs in the study, installation, wiring, programming and testing of the motor + inverter system, as well as the dangers due to errors associated with these operations. However, before the NEO-WiFi, there were factors that limited the availability of motor-inverters: the degree of protection that was needed (motors can be installed out in the open, while inverters could not) and the fact that the motor-inverter, and therefore its keypad, remain removed from whoever is commanding it (imagine, for example, a ventilator that is on a roof). Motive has solved both problems with NEO-WiFi, patented, easy to use, IP65, with removable control panel, remotable wireless, powered by induction when placed in its housing on the motor or by lithium rechargeable batteries. While possessing the most advanced features of the other inverters, NEO-WiFi, thanks to its innovative solutions, is designed as a competitive and user-friendly turnkey integrated system, with all parts, motor, inverter and control designed for outdoor use, and with standard remote control. The manufacturers of pumps, fans, and other machines can thus offer a finished "plug-in" product, without delegating risky and costly installations to their customers. Their customers need only to insert the plug, wherever it is installed, and decide if they want to bring the keypad with them.



Programming and control, that is also remote and wireless. A drastic reduction of installation costs.

A keypad can control simultaneously, or separately, up to 8 motors.

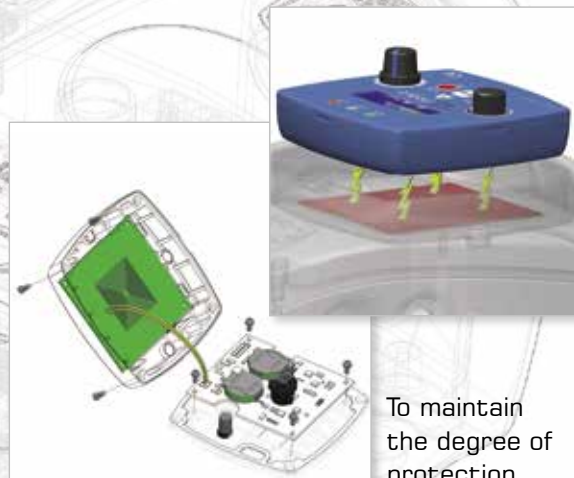

To maintain the degree of protection and eliminate fragile and complicated connectors, the keypad is automatically powered by induction when housed in the lid of the NEO, or, when remote, it is automatically powered by rechargeable batteries that are provided standard, or by BLOCK.



High degree of protection, against dust and water, for outdoor use.



Modbus



The keypad can be positioned or removed from its seat without any tools, because it adheres to it with 4 magnets.





Rotatable keypad.



Incorporated filters of NEO-WiFi-11 and NEO-WiFi-22 make them suitable

for industrial environment EMC. NEO-WiFi-3 , NEO-WiFi-4 and NEO-WiFi-5.5 EMC are compatible not just with Industrial environment, but also light industrial, commercial and residential environments.

Any NEO can be fixed to a wide range of motors of different power and size.



The keypad can be fixed to a metal wall with its magnets or to a concrete wall using inserts.



The keypad is available in two versions: with or without analogue controls.



Thanks to BLUE, motive bluetooth transmitter for NANO and NEO,  and to the free App NEO, you can make the setting or command NEO via tablets or smartphones.



Setting and command can also be made by a PC, thanks to the free PC interface program "Motive Motor Manager"

Examples

Adjusting the flow/pressure/force of a pump, a hydraulic power unit, an oil-hydraulic actuator, a compressor, an extraction fan, a ventilator, etc is normally done through shutters or valves. If we have a choke device of this kind, it means we have chosen not to use a variable speed drive (inverter). In this case, the disadvantages are numerous: inability to program ramping up or stopping; nor to synchronize multiple devices; fewer opportunities for interaction with other machines and controls (such as a pressure transducer), less access to controls, more noise, greater peak currents; shorter life of the motor and of the mechanical parts of the system; and above all the absence of energy savings. It is like controlling the speed of a car just by using the brake.

An inverter also simplifies the installation because a system with direct or star-delta type starting often involves the use of suitably oversized power contactors to counter the high electric arcing caused by the overcurrent normally associated with these starting systems. In addition, protection systems for the motor via circuit breakers should always be provided. So: shutter/valve + cabinet + knife switch + motor control relay + motor overload protection automatic switch could be saved with a variable speed drive. Let's add that in certain applications, just the cost of the choke (think for example of the proportional valve of a hydraulic power unit) exceeds that of an inverter.

So why not just use inverters? Essentially for the ease of assembly (assumed) with respect to an electronic device to be wired up and programmed, the reduced size, the degree of protection from dust and liquids and the ease of use, the difficulty of integrating in

the system the inverter with its cabinet, the accessibility of the controls. Sometimes also the cost of the inverter can be considerable, especially when it is added to that of a cabinet and cables.

With NEO-WiFi these reasons are no longer valid. There remain only the advantages of the inverter. In fact:

- NEO-WiFi is a motor-inverter and as such cancels the need for cables and cabinets, the study, the installation, the wiring, and the testing of the motor+inverter system, as well as the risks associated with possible errors.
- Not requiring cables and cabinets, and being an integral part of the motor, it does not take up space
- Programming is easier than using the TV remote control
- The keypad of the NEO-WiFi is removable, can operate remotely over wireless and can be placed up to 20 meters away. No wiring, no cables. It does not need wiring because it is supplied by induction when placed in its housing on the motor or in the "BLOCK" device, or fed by rechargeable lithium batteries. Imagine for instance the advantage of installing a ceiling fan with this drive and controlling it from wherever you want without any installation cost
- Even a child knows how to use a device with a red button, a green one, a left-zero-right switch and a control knob
- NEO-WiFi is IP65. Its keypad is IP67



WORKING CONDITIONS



Value	Symbol	UOM	NEO-WiFi-3kW	NEO-WiFi-4kW	NEO-WiFi-5.5kW	NEO-WiFi-11kW	NEO-WiFi-22kW
Inverter protection degree*	IP		IP65				
Inverter supply voltage	V_{1n}	V	3x 200-460				
Inverter supply frequency	f_{1n}	Hz	50-60				
Inverter output frequency	f_2	Hz	200% f_{1n} [f_2 0-100Hz (f_{1n} 50Hz)]				
Rated output current from the inverter (to the motor)	I_{2n}	A	7	10	14	22	45
Maximum Starting torque / Rated torque ratio	Cs/Cn	Nm	150% (at I_{2n}) 300% (at $I_{2n}/2$)			200% (7,5kW) 160% (11kW)	150%
Maximum WiFi keypad-inverter communication distance out in the open		mt	20				



III. 3

Further characteristics	NEO-WiFi-3kW	NEO-WiFi-4kW	NEO-WiFi-5.5kW	NEO-WiFi-11kW	NEO-WiFi-22kW
Bluetooth communication with mobile devices	YES (opt. with BLUE)				
Motor control	V/F			vectorial	
Programmer with built-in clock and battery (to make it possible to plan starts and stops)	NO			YES	
EMC for INDUSTRIAL ENVIRONMENT (ref. EN 50081-2)	YES			YES Class A - Cat C2	
EMC for DOMESTIC, AND LIGHT INDUSTRIAL ENVIRONMENT (ref. EN 50081-1, para 5)	YES Class A - Cat C1			optional	
Built in potentiometer with knob	YES (with NANPOT)				
Built in 3PH power knife switch	optional cod. INTEM3X32A			optional cod. INTEM3X63A	
Communication Protocol	MODBUS RS485				
Internal braking resistances	YES				

III. 4



The IP65 degree refers to both the inverter case and to the removable keypad, whether it is placed in the inverter case or whether inverter and keypad are distant from each other. This is possible thanks to:

- adoption of an induction powered system instead of "male-female" connectors,
- shapes of the cases of the 2 items
- special sealing gaskets on the keypad (III. 3) and on the inverter case (III. 4)

NEO-WiFi EMC = Secure operation



Have you ever had a sporadic and inexplicable malfunction of electrical/electronic devices? For example, an automatic gate, a computer, a PLC, a circuit breaker ... If you didn't find the fault, it was probably due to the electromagnetic compatibility of the device (not sufficiently immune to electrical/electromagnetic interference received from the power line or radiated in the air) or to that of other equipment that showed no malfunction but was disturbing your device. Electromagnetic compatibility is a requirement prescribed by law and by the need to guarantee the

operation of all electrical/electronic equipment, on the basis of which it must in practice:

- limit below precise thresholds emissions of electrical and electromagnetic interference which can affect the operation of other devices, whether the interference is radiated through the air or conducted in the power line or in the earth return circuits;
- be immune to a series of conducted and radiated interference that may be present in the environment in which it is intended to operate.

It is important therefore not only to protect the operation of the inverter (variable speed drive), but also to protect all the other devices from it. Electromagnetic compatibility is therefore the result of coexistence without reciprocal interference of devices in the same environment.

In an industrial environment, the immunity level must be higher compared to the others, but on the other hand, in a residential, commercial or light industrial environment, it is necessary to limit potential interference emissions more than in the industrial environment.

So the regulations define these two environments:

DOMESTIC, COMMERCIAL AND LIGHT INDUSTRIAL ENVIRONMENT (ref. EN 50081-1, para 5)	INDUSTRIAL ENVIRONMENT (ref. EN 50081-2, para 5)
<p>This concerns residential, commercial and light industrial locations, both internal and external.</p> <p>Locations with a power supply from 50 to 1000V <u>provided direct from the public network</u> are considered residential, commercial or light industrial locations.</p> 	<p>Industrial environments are characterized by the existence of one or more of the following conditions:</p> <ul style="list-style-type: none"> • presence of industrial, scientific or medical equipment • inductive and capacitive loads are frequently switched • currents and associated magnetic fields are high 

NEO-WiFi EMC = Secure operation

The part of the first definition that we have underlined contradicts a recurrent belief: in fact, not every location that is often considered an "industrial environment" is only that for the EMC regulations. Indeed, the vast majority of companies also fall within the definition of light industry and their facilities and equipment must therefore satisfy the legal requirements of both environments.

Nevertheless, most of the three-phase inverters circulating on the market are declared in conformity with the regulations which relate only to the industrial environment and, at times, they place limitations even on this.

Having said this, and wanting to talk about the EMC advantages of NEO-WiFi, we cite the two main ones:

1. maximum distance between inverter and motor

In a normal motor/inverter installation it is necessary to minimize the parasitic capacitance of the system and for this (but not with NEO-WiFi), the cables connecting motor and inverter should be short and of shielded type, or unshielded but inserted in a duct or metal tube connected to earth. This also because the cables connecting motor and inverter also radiate radio waves. It is not uncommon for inverter manufacturers, in their declaration of conformity, to specify for the sake of correctness the maximum length of the cable connecting motor and inverter and this statement may be considered valid.

With an inverter motor this problem does not exist, because motor and inverter are a single unit. If, however, we were unable to control the inverter motor in its position (under a conveyor belt, in the narrow space in which a hydraulic control unit was installed, on an industrial fan attached to a ceiling, etc.), with a normal inverter motor we would still have to have a control device connected via cable to the inverter. This problem does not exist with NEO-WiFi, whose detachable keyboard is connected to the inverter via authorized and tested radio frequencies.

2. the installation of additional anti-interference filters

To make a compatible inverter, the manufacturer will have to allow for additional costs, such as the insertion of components, shielding and filters. To offer a price apparently more attractive, a frequent trick is to not incorporate in the inverter everything you need and to resolve the problem by requiring you in the instruction manual to buy anti-interference filters separately and install them. A careless buyer may then fool themselves that they have saved, only to find out later, on reading the manual, that if he/she wants to comply with applicable laws and avoid problems operating the inverter or other devices in the same environment, he/she will have to incur additional costs for materials and installation.

Another recurrent story is installing inverters suitable only for industrial environments, even if the company has power supplied directly from the mains, putting at risk the operation of other devices. This leaves the problem to the end user to understand why an automatic gate, a computer, a PLC, a protective circuit breaker or other electronic devices in the same environment will begin to have problems of malfunction which will not be confirmed and resolved by the suppliers of the inverter.



NEO-WiFi was designed as a plug-and-play inverter motor, to avoid the costs of additional materials and labour to the buyer. It had to take into account, viewing the situation seriously, the fact of having been designed for its intended environment, without the need for additional material and installation costs.

Very unusually, therefore, in the NEO-WiFi-3, NEO-WiFi-4 and NEO-WiFi-5.5 project, Motive

has been careful to make it compatible not only with the industrial environment, with high immunity, but also to keep its emissions below the most restrictive thresholds prescribed for the home, commercial and light industrial environment, without the need to install additional external filters.

NEO-WiFi-11 and NEO-WiFi-22, however, because of their greater power, are the standard suitable for installation in industrial environments but require the installation of an optional external anti-interference filter to make them suitable for the domestic, commercial and light industrial environment too.

MOTORS THAT CAN BE CONNECTED

Tab. RP: Power range of motors that can be connected (at 400Vac)

motor-kW	0,13	0,18	0,25	0,37	0,55	0,75	1,1	1,5	1,9	2,2	3	4	5,5	7,5	9,2	11	15	18,5	22	
NEO-WiFi-3kW																				
NEO-WiFi-4kW																				
NEO-WiFi-5.5kW																				
NEO-WiFi-11kW																				
NEO-WiFi-22kW																				

The power that can be applied is dependent not only on the electronic characteristics of NEO-WiFi, but also on the dissipative capacity of its case. It is therefore not allowable to use the electronic board in cases that are different from the original one by removing the electronic board and mounting it in another case.



Tab. RD: Size range of IEC motors that can be connected

motor-IEC type	63	71	80	90S	90L	100	112	132S	132M	160	180	200
NEO-WiFi-3kW												
NEO-WiFi-4kW												
NEO-WiFi-5.5kW												
NEO-WiFi-11kW												
NEO-WiFi-22kW												

It is important that the motor is suitable to be powered by an inverter. A fundamental requirement is that it has reinforced insulation between the phase windings. Others, are the limited current absorption and low temperature rise. The Delphi series of motive motors, as a standard feature, can be powered by an inverter.



MECHANICAL ASSEMBLY

Motor assembly

If the inverter is used at frequencies lower than 50Hz, it becomes necessary to use motors with forced ventilation:



The mechanical fastening with slots (III. 5) allows the NEO-WiFi case to be fixed onto a wide range of Delphi series motive motors from size 71 to size 160 (Table. RD)

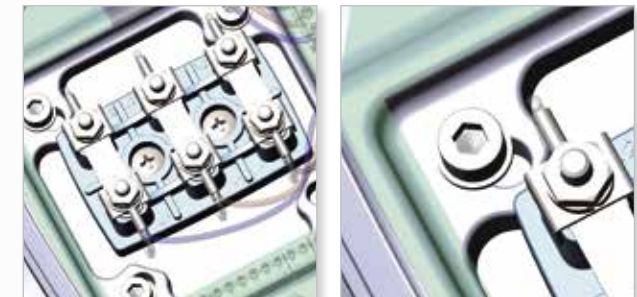

III. 5

Keypad assembly

The keypad is available in two versions:



**Standard version
IP67**

Thanks to 4 magnets incorporated into the keypad case (Ill. 6), the keypad safely rests in its housing, in any assembly position.



Ill. 6



**Optional version with analog controls
IP65**

This also offers the advantage of allowing the keypad to be rotated into 4 positions, depending on the preferred point of view



If the keypad is removed from the NEO-WiFi case, it can be fixed to the wall in 2 ways.

- If the wall is made of metal, by using the magnetism of 4 magnets in the keypad (III. 7).
- Alternatively, it can be fixed onto 2 inserts by using the designated slots on the back of the case (III. 8)



III. 7



III. 8

Each keypad comes equipped with two rechargeable batteries.

BLOCK – keypad external induction recharger



The keypad is attracted and held in BLOCK seat by magnets

The keypad can be positioned in any position.

The keypad is powered by induction.

BLOCK is IP65, 200-260Vac 1PH 50/60Hz



If the wall is made of metal, BLOCK is fixed by the magnetism of its 4 magnets. Alternatively, it can be fixed onto 2 inserts by using the designated slots on the back of BLOCK

Available also in "Ex" version, ATEX certified

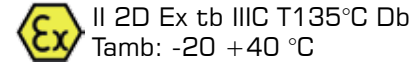

ATEX certified V.F.Drives for zones 21 and 22, Cat. 2 and 3, Dust
 ATEX is the conventional name of the Directive 94/9/EC for the equipment intended for use in potentially explosive atmospheres.
 Motive Variable Frequency Drives NANO Ex and NEO-Ex differ from standard NANO and NEO because they are designed to be used, like motive "Ex" gearboxes, in the ATEX zones 21 and 22, Categories 2 and 3, Groups A, B and C, Dust

Cat	Zone	Description
2	21	A place in which an explosive atmosphere in the form of a cloud of combustible dust in air is likely to occur in normal operation occasionally.
3	22	A place in which an explosive atmosphere in the form of a cloud of combustible dust in air is not likely to occur in normal operation but, if it does occur, will persist for a short period only.

NANO Ex and NEO-Ex are in fact certified for such zones according to the norms IEC 60079-0:2011 - EN 60079-31:2014 by a notified body

AR your value certified
albarubens

CE Ex
 Notified Body n. 2632
 Organismo Notificato n. 2632

EU-TYPE EXAMINATION CERTIFICATE

CERTIFICATO DI ESAME UE DEL TIPO

[1] **ELECTRICAL EQUIPMENT Intended for use in Potentially Explosive Atmospheres - Directive 2014/34/EU-ATEX Annex III/Module B**
 APPARECCHIO ELETTRICO Inteso per l'uso in Atmosfera Potenzialmente Esplosiva - Direttiva 2014/34/EU-ATEX Annex III/Module B

[2] **EU-TYPE EXAMINATION CERTIFICATE n.:** **AR19ATEX067**
 CERTIFICATO DI ESAME UE DEL TIPO n.:

[3] **ELECTRICAL EQUIPMENT:**
 APPARECCHIO ELETTRICO:
 NEO series Variable Frequency Drives:
 NEO 3KW - NEO 4KW - NEO 11KW - NEO 22KW
 NANO series Variable Frequency Drives:
 NANO 0.75kW - NANO 2.2kW
 Motive srl

[5] **MANUFACTURER:**
 COSTRUTTORE:
 Via Le Ghiselle, 20
 25014 Castenedolo (BS) - ITALY

[6] **ADDRESS:**
 INDIRIZZO:

[7] **This ELECTRICAL EQUIPMENT and any variation is specified in the schedule to this certificate and the documents therein referred to.**
 Questo APPARECCHIO ELETTRICO e le varianti sono descritte nell'allegato al presente certificato e nei documenti ivi richiamati.

[8] **Albarubens srl, Notified Body No. 2632, in accordance with Article 17 of the Directive 2014/34/EU-ATEX of the European Parliament and of the Council, dated 26 February 2014, certifies that this ELECTRICAL EQUIPMENT has been found to comply with the Essential Health and Safety Requirements relating to the design and construction of products intended for use in potentially explosive atmospheres given in Annex II to the Directive.**
The examination and test results are recorded in confidential report MOD 7.4.1 - ID: 3635
 Albarubens srl, Organismo Notificato n. 2632, in conformità all'art. 17 della Direttiva 2014/34/UE-ATEX del Parlamento Europeo e del Consiglio, datata 26 Febbraio 2014, certifica che questo APPARECCHIO ELETTRICO è conforme ai Requisiti Essenziali di Sicurezza e Salute per il progetto e la fabbricazione di prodotti destinati ad essere utilizzati in atmosfere potenzialmente esplosive, definiti nell'Allegato II della Direttiva. I risultati dell'esame e dei test sono descritti nel rapporto confidenziale MOD 7.4.1 - ID: 3635

[9] **Compliance with the Essential Health and Safety Requirements has been assured by compliance with the technical standards:**
 La conformità ai Requisiti Essenziali di Sicurezza e Salute è assicurata dalla conformità alle norme tecniche:
EN 60079-0:2012+A11:2013 - EN 60079-31:2014
 except in respect of those requirements listed at item 18 of the Schedule.
 tranne nel caso dei requisiti elencati al punto 18 dell'Allegato.

[10] **If the symbol 'X' is placed after the certificate number, it indicates that the ELECTRICAL EQUIPMENT is subject to the Specific Conditions of Use specified in the next chapter 17.**
 Il simbolo 'X', se presente dopo il numero di certificato, indica che questo APPARECCHIO ELETTRICO è soggetto a Condizioni Speciali per l'uso, specificate nel seguente punto 17.

[11] **This EU-TYPE EXAMINATION CERTIFICATE relates only to the design and construction of the specified ELECTRICAL EQUIPMENT. Further requirements of the Directive apply to the manufacturing process and supply of product.**
 Questo CERTIFICATO DI ESAME UE DEL TIPO è relativo soltanto al progetto ed alla costruzione di questo APPARECCHIO ELETTRICO. Ulteriori requisiti di questa Direttiva si applicano al processo di fabbricazione e fornitura di questo prodotto. Questi requisiti non sono oggetto del presente certificato.

[12] **The marking of the ELECTRICAL EQUIPMENT shall include the following:**
 Questo APPARECCHIO ELETTRICO deve riportare i seguenti contrassegni:
II 2D Ex tb IIIC T135°C Db
Tamb: -20 +40 °C

Saronno (Italy), 21 Jun 2019

ACCREDIA
 1920 N° 2179
 Member of the Association of Italian Accredited Bodies (ASIS) and of the European Association of Accredited Bodies (EA) and of the International Accreditation Forum (IAF) and of the International Laboratory Accreditation Cooperation (ILAC) Mutual Recognition Agreement

Digital signature
 Firmato digitalmente da Giuseppe Terzaghi
 Data: 2019.06.24 16:30:36 +02'00'

ALBARUBENS srl
 The legal representative: ing. Giuseppe Terzaghi

Verity validity and authenticity of this certificate on the website: <https://www.albarubens.it/authentication.php> (Password: NFPIH9)

page 1/3
 JOB: 19/0079 - ID: 3635

Albarubens srl - Via G. Ferrari 21/N - 21047 Saronno (VA) - Italy - P.leg. VA.286283 - Tax code IT 02767050129 - Paid-up capital €100.000,00
 www.albarubens.it - info@albarubens.it - tel: +39 02 96248530 - fax: +39 02 700523656 - Document automatically generated by the Albarubens WebApp 1.87

Connection of the external devices

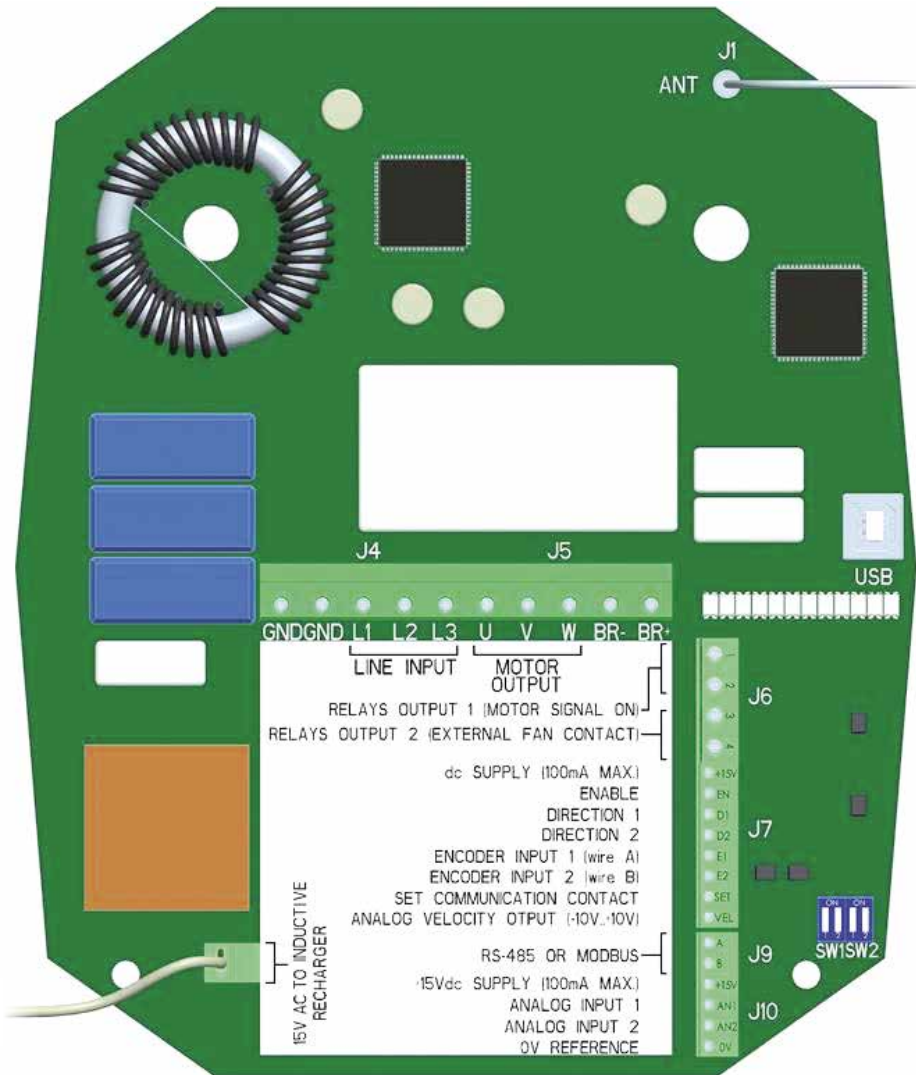

NEO-WiFi-3, NEO-WiFi-4, NEO-WiFi-5.5

	terminal	function
	1	J6 normally open contact that closes when the motor starts
	2	
	3	
	4	
	+ 15V	J7 15Vdc output (max 100mA) enables/disables the inverter operation direction 1 (rotation sense 1 of motor) direction 2 (rotation sense 2 of motor) encoder or proximity sensor input (Channel A) encoder or proximity sensor input (Channel B) communication channel selection (closing this contact with 15V) analogue output 1 (-10V... +10V) proportional to the motor speed between Vmin (0V) and Vmax (10V)
	EN	
	D1	
	D2	
	E1	
	E2	
	SET	
	VEL	
	A	J9 RS485 (for Master-Slave connection) or Modbus
	B	
	+ 15V	J10 15Vdc output (max 100mA) analogue input 1 (external potentiometer / external signal for speed 0-10Vdc / 0-20mA) (from keypad version 2.05, also 4-20mA) analogue input 2 (external potentiometer / external signal for speed 0 ÷ 15Vdc/ 0-20mA) 0Vdc
	AN1	
	AN2	
	0V	
	⏏	J4 grounding grounding phase 1 for inverter power supply from net phase 2 for inverter power supply from net phase 3 for inverter power supply from net
	L1	
	L2	
	L3	
	U	J5 U phase motor connection V phase motor connection W phase motor connection internal braking resistances connection (opt. External), or motor dc brake connection
	V	
	W	
	BR-	
	BR+	
	USB	PC connection
	15Vac	15Vac HF output for induction recharger

Illustration 13 - Diagram NEO-WiFi-3, NEO-WiFi-3, NEO-WiFi-4, NEO-WiFi-5.5 kW power board

ELECTRICAL ASSEMBLY

NEO-WiFi-11 / NEO-WiFi-22 (control board)

	terminal	function
A02 0V	J15	analogue output 2 (0...+10V) for internal IGBT temperature signal (0...100°C). Activated from V1.06
A01 0V	J14	analogue output 1 (-10V...+10V) for motor speed signal (absolute value) and rotation sense
15V 5V	J16	15Vdc output (max 100mA) 5Vdc output (max 100mA)
A+ A- B+ B- Z+ Z- 0V 0V	J11	channel A+ input channel A- input channel B+ input channel B- input channel Z+ input channel Z- input grounding grounding
A B	J10	Modbus communication gate
A B	J9	RS485 Bus, (for Master-Slave group connection)
15V AN1 AN2 D2 D1 SET EN 0V USB	J8	15Vdc output analogue input 1 (external potentiometer / external signal for speed 0-10Vdc / 0-20mA) (from keypad version 2.05, also 4-20mA) analogue input 2 (external potentiometer) direction 2 (rotation sense 2 motor with external controls) direction 1 (rotation sense 1 motor with external controls) communication channel selection (closing this contact with 15V) enables/disables the motor operation 0Vdc PC connection

NEO-WiFi-11 (power board)

	terminal	function
0V IND AC IND	J4	15Vac HF output for induction recharger
0V DC FAN 12V DC FAN	J1	12V relay output for internal cooling fan (it closes when the IGBT temperature exceeds 45°C)
Ext FAN Ext FAN	J3	normally open contact that closes when the IGBT bridge temperature exceeds 45°C, in order to enable the start of an eventual optional external fan
ALARM ALARM MOT ON MOT ON	J2	normally open contact that closes when there is an alarm, simultaneously shown on the keypad display normally open contact that closes when the motor starts
BR+ BR- GND	J10	internal braking resistances connection (opt. External), or motor dc brake connection grounding
U V W	J9	W phase motor connection V phase motor connection U phase motor connection
L3 L2 L1 GND	J5	phase 1 for inverter power supply from net phase 2 for inverter power supply from net phase 3 for inverter power supply from net grounding

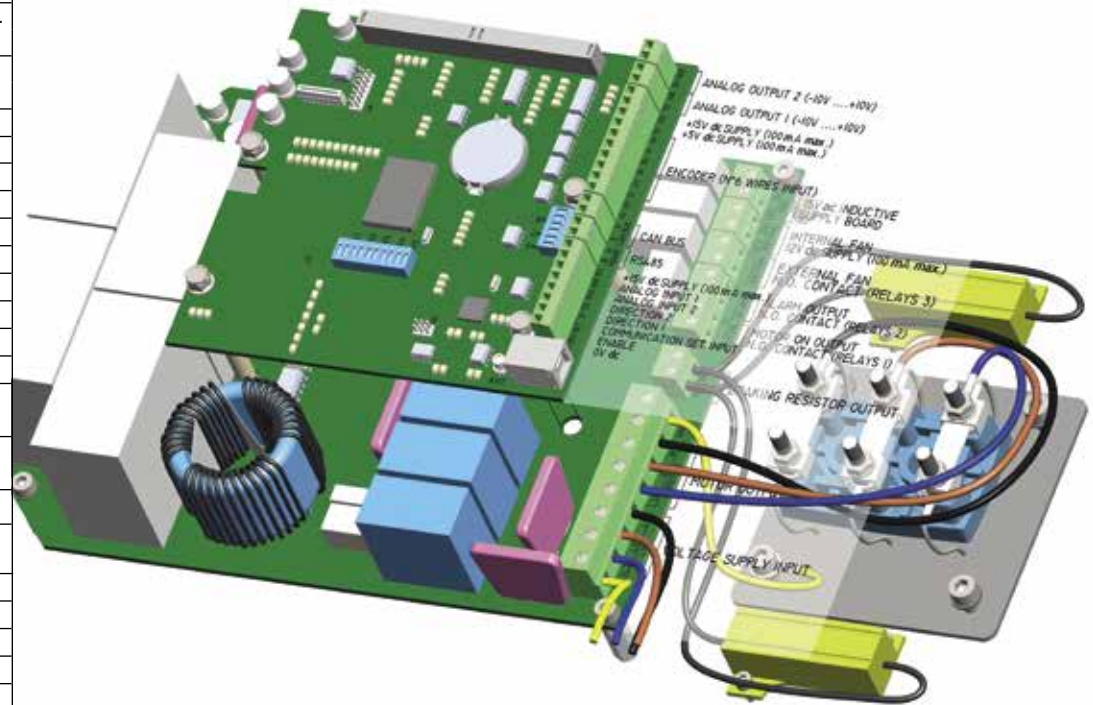

NEO-WiFi-22 (power board)

terminal	function
	15Vac HF output for induction recharger
	12V relay output for internal cooling fan (it closes when the IGBT temperature exceeds 45°C).
	normally open contact that closes when there is an alarm, simultaneously shown on the keypad display.
	relay normally open contact that closes when the motor starts
	power supply for eventual induction single phase cooling fans
	internal braking resistances connection (opt. External), or motor dc brake connection
	grounding
	W phase motor connection
	V phase motor connection
	U phase motor connection
	phase 1 for inverter power supply from net
	phase 2 for inverter power supply from net
	phase 3 for inverter power supply from net
	grounding

Keypad-inverter communication

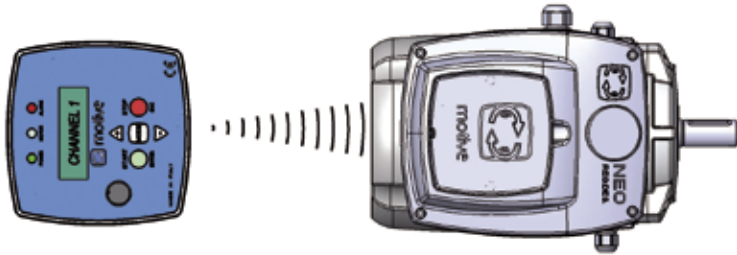

The keypad during the functioning of the motor shows, alternating them, the following two sets of data

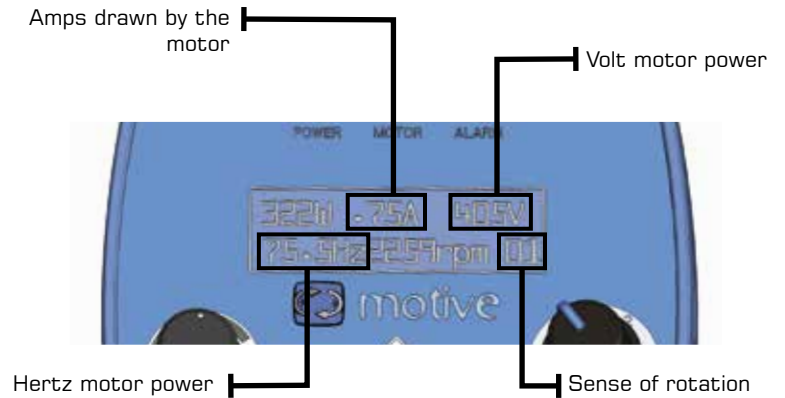
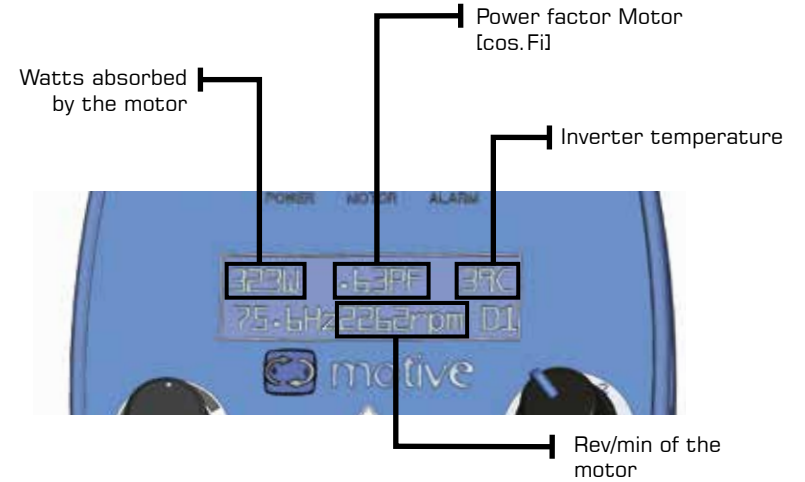

It is instead possible to obtain a synchronous behaviour of 2-8 NEO-WiFi with one keypad, connected them in master-slave mode. Slaves work without keypad, once they have been configured in the RS485 connection.



Separate control of multiple motors with multiple keypads with separate channels from 1 to 127

Since keypad version V1.12 (you can see it for 2 seconds when you switch the keypad on) it is possible to see the battery charge.



PROGRAMMING

keypad buttons



led keypad

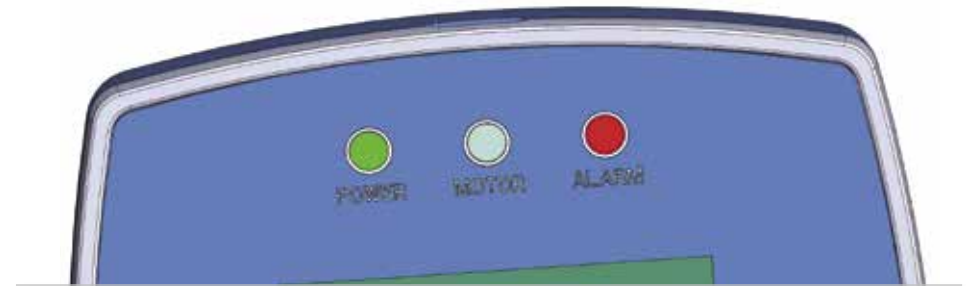





Button	Description
	To enter the function menu
 START ENTER	To start the motor / to access the sub-menu or to enter the function and change its values
	Allows you to scrolls up through the menu items or change in positive the values of the variables; at the end of the change press ENTER. During operation also allows to increase the speed of the motor
	Allows you to scroll down through the menu items or change in negative the values of the variables; at the end of the change press ENTER. During operation also allows to increase the speed of the motor
 STOP ESC	To stop the motor / to exit from the sub-menu (by entering the main menu); to exit from the main menu enabling the motor controls and automatically saving the set data if pressed in a rapid sequence (at the end it must show the writing "DATA SAVED").

Table 3: Buttons



Led	Description
Power ON	 Green - signals the presence of mains voltage on the feed
Motor ON	 Green - Motor functioning
Alarm	 Red - signals an anomaly (see list of Alarms) when turned on

Table 4: Led description

PROGRAMMING

Functions menu

Menu	Sub-menu	Description
Language		Italian / English
Communication	1. Motor Code 2. Radio frequency	1. from 1 to 127 2. 860...879 MHz
Motor data	1. Rated power P2 [kW] 2. Rated voltage [V] 3. Rated current [A] 4. Rated frequency [Hz] 5. Rated RPM; 6. Power factor $\cos\phi$ 7. Maximum torque slide	1. 0.09÷3.0 (NEO-3); 0.09÷11.0 (NEO-11); 0.09÷22.0 (NEO-22) 2. from 180V to 460V 3. 0.6÷7A (NEO-3); 0.6÷22.0A (NEO-11); 0.6÷45.0A (NEO-22) 4. from 50 to 100 5. from 350 to 6000 6. from 0.50 to 0.90 7. from 10 to 50%
Advanced Functions	Access to the advanced functions menu	To access enter numeric access Password
Data save/Reset	<ul style="list-style-type: none"> • Yes save: the changes made are saved • Not save: returns to the values preceding the changes • Factory data: resets the factory values • Data memory reset (accessed with advance password 541) 	Save the changed data, or restore the default values NOTE: auto-saves every time you exit the from function menu.

Table 5: Main menu

NOTE: To enter the motor data refer to the data on the plate of the motor.

Advanced functions menu:

Advanced Functions Menu	Sub-menus	Description
Motor limitations	1. Internal speed [RPM] 2. Rotation [0, 1]; 3. Maximum speed [%] 4. Minimum speed [%] 5. Acceleration [s] 6. Deceleration [rpm/s] 7. Maximum inrush current [%] 8. Magnetization [%] 9. Braking Joules	1. From 17 to 6000 RPM (default, \approx 280rpm); 2. 0=clockwise, 1=counter-clockwise; 3. from 2 to 200% 4. from 2 to 100% 5. from 0.1 to 99.9 6. from 0.1 to 99.9 7. 80÷150 (NEO-3) 80÷200 (NEO-11) 80÷150 (NEO-22) 8. from 70 to 120. Default 100%. Increasing this %, at the same frequency, you increase the Volts to the motor (up to the max value of the power net voltage minus the circuit falls), thus increasing the magnetic flux in the motor. This raises the no-load current and enhances the torque up to the motor saturation. 9. from 100 to 9900 [Joule]; default 300 (NEO-3)/1000 (NEO-11/22). To be increased if external resistances are used

PROGRAMMING

Advanced functions menu:

Advanced Functions Menu	Sub-menus	Description
Type of command	<ol style="list-style-type: none"> 1. Enable restart 2. Dead Time after alarm [s] 3. Start/Stop Source 4. Speed Signal 5. Feedback 6. Encoder pulses/revolution integer 7. N. pulses/revolution decimal 8. RS485 Master Slave 9. T/R fault stop (ON/OFF) 	<ol style="list-style-type: none"> 1. Enables the restart after a crash caused by lack of mains voltage or alarm (ENABLED / DISABLED). Default is DISABLED 2. Waiting time before the reboot, follows a stop caused by an alarm condition; 3. • From keypad button only • from keypad button and keypad selector • external remote wired control 4. • Internal speed • keypad potentiometer • AN2 external potentiometer • signal 0-10V on AN1 (default 0-20mA) • signal 4-20mA on AN1 (default 0-20mA); 5. • Open ring • Encoder; 6. number of pulses/revolution of encoder (default 256); 7. Decimal part of the number of pulses/revolution of encoder (e.g. 0); 8. Motor number / Total n. of motors in group (1/1 default for single motor; 1/2 for master motor of total 2 motors group, 2/2 for the slave motor of 2 motors group, etc- n. of slave motors max=8) 9. When this function is ON, it switches off the motor if the T/R radio communication between keypad and NEO is missing for more than 5 seconds. Default is set on OFF.
Electromagnetic brake	<ol style="list-style-type: none"> 1. Electromagnetic braking: ON/OFF 2. Voltage [V] feed of the brake coil 	<p>Enabling this function, the electromagnetic brake is energized when the motor starts and is de-energized at the end of the deceleration ramp of the motor.</p> <ol style="list-style-type: none"> 1. Brake enabling (1=ON is enabled, 0 is disabled), with terminations to be connected to BR+ and BR- of the power board; 2. Supply voltage of the brake coil, selectable between two values: 104Vdc or 180Vdc (download the DELPHI motor manual from www.motive.it).
P.I.D. factors (it's like a cruise control: NEO compares the rpm set by the keypad to a measured feedback)	<ol style="list-style-type: none"> 1. K Proportional factor 2. K Integral factor 	<p>For speed control in feedback</p> <ol style="list-style-type: none"> 1. $K_{proportional}$: 1-100. Multiplies the error of the reference quantity 2. $K_{integral}$: 1-100. Multiplies the integral of the error
Clock setting (function based on the battery clock, which is there only on NEO-11 and NEO-22)	Date and hour setting: to unlock the clock, modify the SECONDS value.	Year: XX Month: XX Day: XX Hour: XX Minute: XX Second: XX
Starts Timer (function based on the battery clock, which is there only on NEO-11 and NEO-22; not there on NEO-3)	Timer ON/OFF	<p>When the Timer is ON, you can set up to 5 programs (consecutive starts/stops) inside 24 hours, which will be repeated every day. Every day of the week will be the same, and you cannot set different programs for different week days.:</p> <ul style="list-style-type: none"> • P1: XX (Start HOUR 1), YY (Start MIN 1); A1: ZZ (Stop HOUR 1); WW (Stop MIN 1); • P2: XX (Start HOUR 2), YY (Start MIN 2); A1: ZZ (Stop HOUR 2); WW (Stop MIN 2); • etc.
Alarm history	List of alarms recorded	View in chronological order (from first to last) all the last 99 Alarm events (chap. 9) recorded during the life of the inverter. The same data is saved in the memory and is made available for analysis from the PC by means of a USB connection for the technical support and repair service (ATTENTION: only with inverter not powered).

Table 6: Advanced functions menu

SMARTPHONE/TABLET/PLC/PC

As well as via wireless keypad, you can program, control, monitor and see the recorded alarm events, also via:

1. Smartphone/tablet:



2. PLC via MODBUS



3. PC:

DECLARATION OF CONFORMITY



motive

Motive s.r.l.
Via Le Ghiselle, 20
25014 Castenedolo (BS)
Tel.: +39 030 2677087
Fax: +39 030 2677125
motive@e-motive.it
www.motive.it



Declaration of conformity

Motive srl with seat in Castenedolo (BS) - Italy

declares, under its exclusive responsibility, that its range of "NEO-WiFi" inverters and motor-inverters is constructed in accordance with the following international regulations (latest edition)

- EN60034-1. Rotating electrical machines: rating and performance
- EN60034-5. Rotating machines: definition of degrees of protection
- EN 60034-6. Rotating machines: methods of cooling
- EN60034-7. Rotating electrical machines - Part 7: Classification of types of construction, mounting arrangements and terminal box position
- EN60034-8. Terminal markings and direction of rotation for rotating electrical machines
- EN60034-30. Rotating electrical machines: efficiency classes of single-speed, three-phase, cage-induction motors
- EN50347. General purpose three-phase induction motors having standard dimensions and outputs - Frame numbers 56 to 315 and flange numbers 65 to 740
- EN60335-1. Safety of household and similar electrical appliances
- EN 60335-2-41. Safety of household and similar electrical appliances - Part 2 Particular requirements for pumps
- EN 55014-2. Electromagnetic compatibility. Requirements for household appliances, electric tools and similar apparatus. Part 2: Immunity
- EN 61000-3-2. Limits for harmonic current emissions (equipment input current <= 16 A per phase).
- EN 61000-3-3. Limitation of voltage fluctuations and flicker in low-voltage supply systems, for equipment with rated current <= 16 A
- EN 61000-3-12. Limits for harmonic currents produced by equipment connected to public low-voltage systems with rated input current greater than 16 A and <= 75 A per phase
- EN61000-6-4. Electromagnetic compatibility (EMC): Part 6-4: Generic standards - Emission standard for industrial environments
- EN 50178. Electronic equipment for use in power installations
- ETSI 301 489-3 Electromagnetic compatibility standard for radio equipment. Part 3: Specific conditions for Short-Range Devices (SRD) operating on frequencies between 9 kHz and 40 GHz.

EMC for DOMESTIC, COMMERCIAL AND LIGHT INDUSTRIAL ENVIRONMENT (ref. EN 50081-1, para 5)	NEO-WiFi-3 Cat. C1	NEO-WiFi-11 NEO-WiFi-22 Cat. C2
EMC for INDUSTRIAL ENVIRONMENT (ref. EN 50081-2, para 5)	YES (since V2.01)	optional
	YES	YES

as required by the Directives

- Low Voltage Directive (LVD) 2006/95/EC
- Electromagnetic Compatibility Directive (EMC) 2004/108/EEC
- Ecodesign Directive for energy related products EEC 2009/125

NB: the Machinery Directive (MD) 2006/42/EC expressly excludes from its scope electric motors (Art. 1, paragraph 2)

Castenedolo, 1 January 2013
The Legal Representative *Giorgio Basso*

Reg. Imprese BS n° 736200000 - N. REA 422301
Cod. Fisc. n° P. IVA 03582980374

DIMENSIONS of NEO-WIFI-3 and KEYPAD

NEO-WIFI-4, NEO-WIFI-5.5, NEO-WIFI-11

NEO-WIFI-22



TERMS OF SALE AND GUARANTEE

ARTICLE 1 GUARANTEE

1.1 Barring written agreements, entered into between the parties hereto each time, Motive hereby guarantees compliance with specific agreements.

The guarantee for defects shall be restricted to product defects following design, materials or manufacturing defects leading back to Motive.

The guarantee shall not include:

- * Faults or damages ensuing from transport. Faults or damages ensuing from installation defects; incompetent use of the product, or any other unsuitable use.
- * Tampering or damages ensuing from use by non-authorized staff and/or use of non-original parts and/or spare parts;
- * Defects and/or damages ensuing from chemical agents and/or atmospheric phenomena (e.g. burnt out material, etc.); routine maintenance and required action or checks;
- * Products lacking a plate or having a tempered plate.

1.2 Returns to credit or replace will be accepted only in exceptional cases; however returns of goods already used to credit or replace won't be accepted in any case.

The guarantee shall be effective for all Motive products, with a term of validity of 12 months, starting from the date of shipment.

The guarantee shall be subject to specific written request for Motive to take action, according to statements, as described at

the paragraphs herein below. By virtue of aforesaid approval, and as regards the claim, Motive shall be bound at its discretion, and within a reasonable time-limit, to alternatively take the following actions:

- a) To supply the Buyer with products of the same type and quality as those having proven defective and not complying with agreements, free ex-works; in aforesaid case, Motive shall have the right to request, at Buyer's charge, early return of defective goods, which shall become Motive's property;
- b) To repair, at its charge, the defective product or to modify the product which does not comply with agreements, by performing aforesaid action at its facilities; in aforesaid cases, all costs regarding product transport shall be sustained by the Buyer.
- c) To send spare parts free of charge: all costs regarding product transport shall be sustained by the Buyer.

1.3. The guarantee herein shall assimilate and replace legal guarantees for defects and discrepancies, and shall exclude any other eventual Motive liability, however caused by supplied products; in particular, the Buyer shall have no right to submit any further claims. Motive shall not be liable for the enforcement of any further claims, as of the date the guarantee's term of validity expires.

ARTICLE 2

CLAIMS

2.1. Claims, regarding quantity, weight, gross weight and colour, or claims regarding faults and defects in quality or compliance, and which the Buyer may discover on goods delivery, shall be submitted by a max. 7 days of aforesaid discovery, under penalty of nullity.

ARTICLE 3 DELIVERY

3.1. Any liability for damages ensuing from total or partial delayed or failed delivery, shall be excluded.

3.2. Unless differently communicated by written to the Client, the transport terms have to be intended ex-works.

ARTICLE 4

PAYMENT

4.1. Any delayed or irregular payments shall entitle Motive to cancel ongoing agreement, including agreements which do not regard the payments at issue, as well as entitling Motive to claim damages, if any. Motive shall, however, have the right, as of payment's due date and without placing in arrears, to claim interest for arrears, to the extent of the discount rate in force in Italy, increased by 12 points. Motive shall also have the right to withhold material under repair for replacement. In the case of failed payment, Motive shall have the right to cancel all guarantees of materials, as regards the insolvent Client.

4.2. The Buyer shall be bound to complete payment, including cases whereby claims or disputes are underway.



**DOWNLOAD
THE TECHNICAL
MANUAL FROM
WWW.MOTIVE.IT**

ALL DATA HAVE BEEN WRITTEN AND
CHECKED WITH THE
GREATEST CARE.

WE DO NOT TAKE ANY RESPONSIBILITY FOR POSSIBLE ERRORS OR
OMISSIONS.

MOTIVE CAN CHANGE THE
CHARACTERISTIC OF THE SOLD
ITEMS ON HIS FIRM OPINION AND
IN EVERY MOMENT.

the brothers:



NEO-PUMP

http://v.youku.com/v_show/id_XMzMyMDM0OTM3Ng==.html?spm=a2h1n.8251843.playList.5!11~1!2~3~A&f=51459639&o=1



NEO-SOLAR

http://v.youku.com/v_show/id_XMzMyMDQ1MjgwOA==.html?spm=a2h1n.8251843.playList.5!2~1!2~3~A&f=51459639&o=1



ASK OUR FURTHER CATALOGUES:



Motive s.r.l.

Via Le Ghiselle, 20

25014 Castenedolo (BS) - Italy

Tel.: +39.030.2677087 - Fax: +39.030.2677125

web site: www.motive.it

e-mail: motive@motive.it



AREA DISTRIBUTOR

