

motive

manual addendum

SV Ex

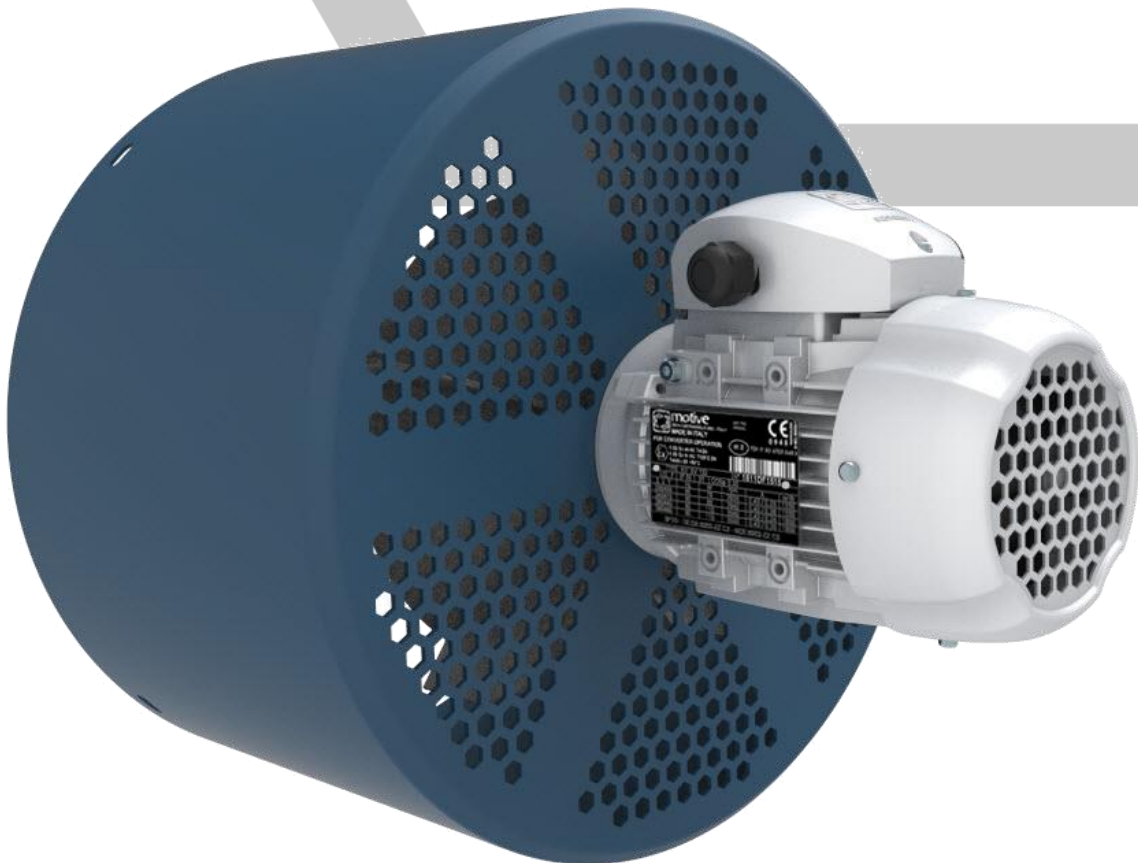



II 2G Ex h IIC T4 Gb
II 2D Ex h IIIC T135°C Db
Tamb=-20 +40 °C



II 2G Ex eb IIC T4 Gb
II 2D Ex tb IIIC T135°C Db
Tamb=-20 +40 °C



Reference list:

Norma (ult. ediz.)	Titolo
Dir. 2014/34/UE	Equipment and Protective systems intended for use in Potentially Explosive Atmospheres. Safety requirements
IEC 60034-5:2020	Rotating electrical machines – Part 5: Degrees of protection provided by the integral design of rotating electrical machines (IP code) – Classification Internal methods Tests not related to standards, developed by laboratory or under client's specification
EN IEC 60079-0:2018	Explosive atmospheres – Part 0: Equipment – General requirements
EN 14986:2017	Design of fans working in potentially explosive atmospheres
EN IEC 80079-36:2016	Explosive atmospheres – Part 36: Non-electrical equipment for explosive atmospheres – Basic method and requirements
EN IEC 60079-7:2015/A1:2018	Explosive atmospheres – Part 7: Equipment protection by increased safety “e”
EN 60079-31:2014	Explosive atmospheres – Part 31: Equipment dust ignition protection by enclosure “t”
IEC 60204-1:2018	Safety of machinery – Electrical equipment of machines – Part 1: General requirements
UKSI 2019:696	

Field of application

The person authorized to do the work is responsible for the zones sharing. He must follow the norms EN 60079-31, EN60079-14, EN 60079-17 and EN 60079-19 (whenever their application is possible).

The eventual dust deposits mustn't have a thickness > 5mm.

Conformity declaration

The conformity declaration reported in this addendum, is the document that testifies the product conformity to the Directive 2014/34/UE.

The validity of such certificate is related to the respect of the instructions specified in the use and maintenance manual, together with the following additional instructions.

Additional instructions

The person authorized to do the work in an ambient exposed to explosion risk must be instructed about the right procedure for the use of the motor, respecting all norms related to safety, installation and use.

Motors must be protected against over-heating by suitable control means that must be chosen, considering the working conditions, according to the norm EN60079-15, EN60079-0 and EN60079-31.

All Motive Power cooling fans SV Ex are standard equipped with 3 PTO 130°C temperature probes to be connected to a suitable release device as reported in EN 50495 standard.

It is forbidden to open the terminal box to connect electric wires or make any intervention in presence of explosive atmosphere. Before any of such operations, disconnect the motor from the electric power supply and avoid the possibility of any accidental switching on of the motor.

Ground connection must be done (with galvanized screw and spring washer supplied) inside the terminal box (fig.1) and by using the screw on the frame (fig.2).

The section of the ground wire connected to the motor frame must have a minimum section of 4 mm².

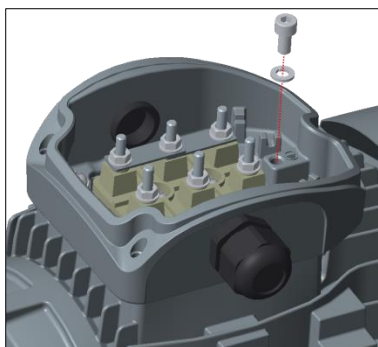

fig.1

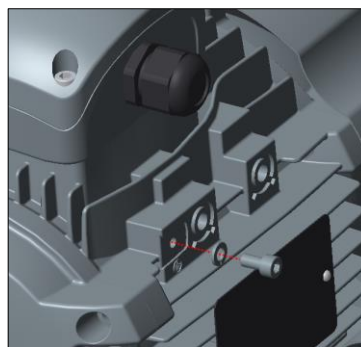

fig.2

For correct tightening of the grounding screws, please refer to the table below.

	M4	M5	M6
Nm	2	3,2	5

Installation precautions

For the installation of the Power cooling please consider the following:

- make sure that no damages have occurred during transport.
- remove carefully the components of the plant from the wrapping material and any other protective devices.
- make sure that the value of the voltage on the motor plate is the same as the voltage of mains.
- surfaces in contact with the electric bonding and the rating plate must not be varnished.
- make sure that the fan cover is well tightened to the motor body.
- rotate the rotor manually in order to verify the absence of any dragging.
- check that the direction of rotation is the same as that indicated on the fan cover.
- do not hinder the ventilation. The discharged air, together with the air coming from other groups, must not be immediately re-aspirated.
- verify the correct grounding of the motor.

Electrical and thermal protections

Protections must be chosen based on the specific running conditions, according to standards EN60079-14 and EN61241-14.

External protections:

- Protection against overcurrent and short-circuits; this protection can be made with the magnetothermic circuit breaker or with fuses; these must be calibrated on the motor current.
- Protection against overload by thermal relay that controls a power line contactor upstream the motor.
- If special conditions or synchronised operation with other machines or parts of machines require it, protection against power failures or dips by means of a minimum voltage relay that controls an automatic power knife switch.

Internal protections:

The electrical protections on the motor power supply may not be sufficient to protect against overloads.

Connecting built-in protections on the windings solves this problem:

- PTO bimetallic probe (normally-closed electromechanical device that becomes open when the threshold temperature is reached).

The reset of this cut-out must be performed manually only, and not automatically. The user, in compliance with the norms, must use a tripping relay out in compliance with IEC 61508 standard (Fail Safe type).

Bearings lubrication

Motors with shielded self-lubricating bearings “ZZ” do not require any periodic lubrication.

Bearings life ranges from 3 up to 5 years according to the axial and radial loads that are charged on the shaft and to environmental conditions the motor is used in.

PECULIAR FEATURES OF SV Ex POWER COOLING



Manual Addendum

Reinforced fan cover with increased thickness

Motive DELPHI 2GD Ex e motor

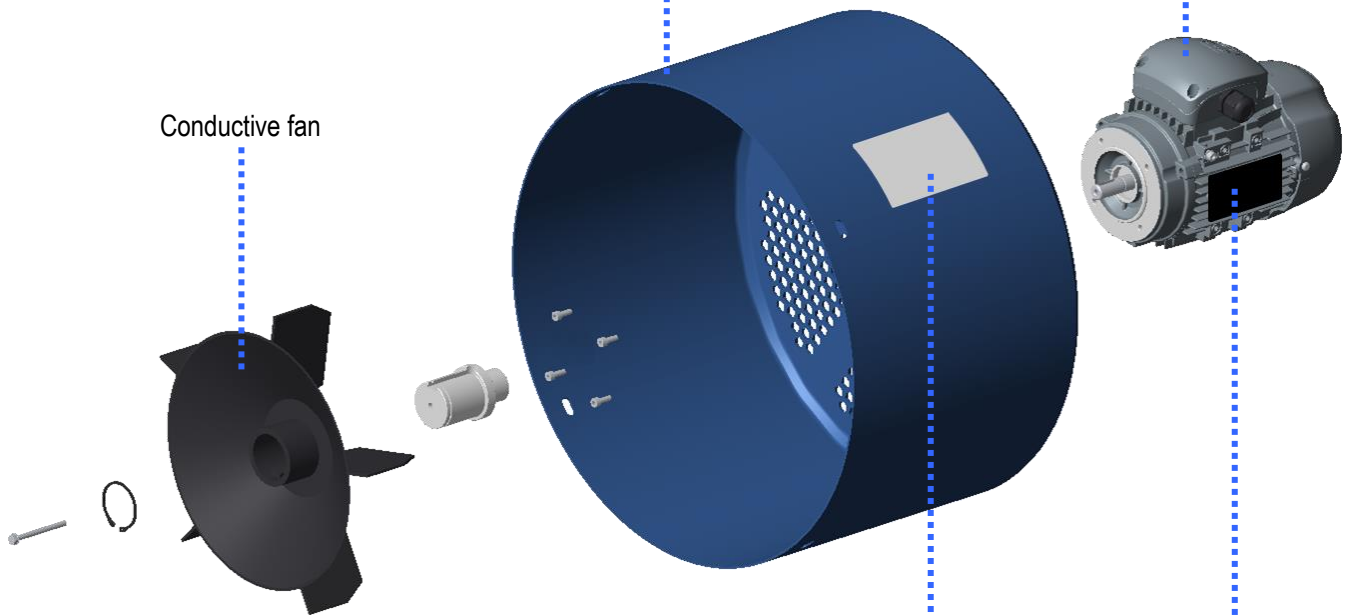

Conductive fan

Manufacturer's mark



motive
25014 CASTENEDOLO (BS) - ITALY
DES. & MADE IN ITALY

CE
0 9 4 8

KIT SV Ex 2GD

 II 2G Ex h IIC T4 Gb
II 2D Ex h IIC T135°C Db
Tamb= -20 +40°C

TÜV IT 21 ATEX 112 AR

Notified body number

ATEX certificate number

Protection against explosion

Power cooling type

IP Protection index



motive
25014 CASTENEDOLO (BS) - ITALY
MADE IN ITALY

SEE THE MANUAL

CE
0 9 4 8
3-IEC 60034-1

FOR CONVERTER OPERATION

 II 2G Ex eb IIC T4 Gb
II 2D Ex tb IIC T135°C Db
Tamb= -20 +40°C

IE 2 TÜV IT 20 ATEX 048 X

KIT SV TYPE N*

I.C.L.F	IP.65	S1	COSφ	IA/In	rpm	A	m³/h
Δ.V.Y.	Hz	W					
230/400	50						
240/415	50						
260/440	60						
280/480	60						

3PTO - DE: - NDE:

YYMM production date
Serial number

SV Ex POWER COOLING CLASSIFICATION

For GAS **G**

CE	Ex	II	2	G	Ex	h	IIC	T4	Gb
①	②	③	④	⑤	⑥	⑦	⑧	⑨	⑩

①	CE marking
②	ATEX code for prevention of explosion
③	Surface industries
④	An area where explosive atmospheres may be present during normal operations (Zone 1)
⑤	Protection against gas combustion
⑥	Explosion protection: International
⑦	Non-electrical equipment
⑧	For instance, for Hydrogen. Equipment marked as suitable for Group IIC is also suitable for IIB and IIA
⑨	T4 for maximum surface temperature of 135°C
⑩	Extended level of protection in hazardous zones with explosive gas mixtures

For DUST **D**

CE	Ex	II	2	D	Ex	h	IIIC	T135°C	Db
①	②	③	④	⑤	⑥	⑦	⑧	⑨	⑩

①	CE marking
②	ATEX code for prevention of explosion
③	Surface industries
④	An area where explosive atmospheres may be present, in the form of a flammable cloud of dust in the air, during normal operations (Zone 21)
⑤	Protection against dust combustion
⑥	Explosion protection: International
⑦	Non-electrical equipment
⑧	For conductive dust. Equipment marked as suitable for Group IIIC is also suitable for IIIB and IIIA
⑨	Maximum surface temperature of 135°C
⑩	Extended level of protection in flammable dust atmospheres

Fan motor marking

For GAS **G**

CE	Ex	II	2	G	Ex	eb	IIC	T4	Gb
①	②	③	④	⑤	⑥	⑦	⑧	⑨	⑩

①	CE marking
②	ATEX code for prevention of explosion
③	Surface industries
④	An area where explosive atmospheres may be present during normal operations (Zone 1)
⑤	Protection against gas combustion
⑥	Explosion protection: International
⑦	Increased safety
⑧	For instance, for Hydrogen. Equipment marked as suitable for Group IIC is also suitable for IIB and IIA
⑨	T4 for maximum surface temperature of 135°C
⑩	Extended level of protection in hazardous zones with explosive gas mixtures

For DUST **D**

CE	Ex	II	2	D	Ex	tb	IIIC	T135°C	Db
①	②	③	④	⑤	⑥	⑦	⑧	⑨	⑩

①	CE marking
②	ATEX code for prevention of explosion
③	Surface industries
④	An area where explosive atmospheres may be present, in the form of a flammable cloud of dust in the air, during normal operations (Zone 21)
⑤	Protection against dust combustion
⑥	Explosion protection: International
⑦	Enclosure protection
⑧	For conductive dust. Equipment marked as suitable for Group IIIC is also suitable for IIIB and IIIA
⑨	Maximum surface temperature of 135°C
⑩	Extended level of protection in flammable dust atmospheres



Motive s.r.l.
Via Le Ghiselle, 20
25014 Castenedolo (BS)
Tel.: +39 030 2677087
Fax: +39 030 2677125
motive@motive.it
www.motive.it

Declaration of EU Conformity

Motive srl based in Castenedolo (BS) - Italy

declares as manufacturer, under its own exclusive responsibility, that its range of

Three phase power cooling fans of the series "SV Ex"

complies with the following directives and standards:

- EC Directive **2014/34/EU**: concerning "equipment and Protective systems intended for use in Potentially Explosive Atmospheres"

Marking:



II 2G Ex h IIC T4 Gb
II 2D Ex h IIC T135°C Db
Tamb=-20 +40 °C

Voluntary type examination certificate number
(edit by TÜV Italia, Notified Body Number 0948): TÜV IT 21 ATEX 112 AR

as in accordance to the European Standards:

- **IEC 60034-5:2020** Rotating electrical machines – Part 5: Degrees of protection provided by the integral design of rotating electrical machines (IP code) – Classification Internal methods Tests not related to standards, developed by laboratory or under client's specification
- **EN IEC 60079-0:2018** Explosive atmospheres – Part 0: Equipment – General requirements
- **EN 14986:2017** Design of fans working in potentially explosive atmospheres
- **EN ISO/IEC 80079-36:2016** Explosive atmospheres – Part 36: Non-electrical equipment for explosive atmospheres – Basic method and requirements
- **EN IEC 60079-7:2015/A1:2018** Explosive atmospheres – Part 7: Equipment protection by increased safety "e"
- **EN 60079-31:2014** Explosive atmospheres – Part 31: Equipment dust ignition protection by enclosure "t"
- **IEC 60204-1:2018** Safety of machinery – Electrical equipment of machines – Part 1: General requirements

The machines are supplied without electrical connections to the control panels or any pneumatic and hydraulic supply connections.

It is therefore forbidden to use them until the plant into which they are incorporated has been declared as compliant with the provisions of the Machinery Directive **2006/42/EC** and Directive **2014/34/EU** and plant's analysis was not done as compliant with Directive **99/92/EC**.

Castenedolo, 10th September 2021
The legal Representative

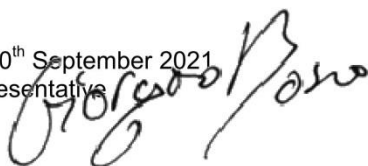



DICHIARAZIONE DECLARATION

CERTIFICAT

CERTIFICADO

СЕРТИФИКАТ

認證證書

CERTIFICATE

ZERTIFIKAT

- [1] **AVVISO DI RICEVIMENTO**
ACKNOWLEDGEMENT OF RECEIPT
- [2] **Apparecchiature o Sistemi di Protezione destinati ad essere utilizzati in atmosfere potenzialmente esplosive Direttiva 2014/34/UE**
Equipment or Protective System or Component intended for use in potentially explosive atmospheres Directive 2014/34/EU
- [3] Numero dell'avviso di ricevimento: **TÜV IT 21 ATEX 112 AR**
Acknowledgement of receipt number:
- [4] Apparecchiatura o sistema di protezione:
Equipment or protective system:
Servoventilazione trifase per motori elettrici serie SV Ex
Three-phase power cooling for electric motors series SV Ex
- [5] Identificazione del fascicolo tecnico data dal richiedente:
Technical file reference given by applicant:
FASCICOLO TECNICO SERVOVENTILAZIONI ATEX 2GD FT_SVEX2GD
ATEX 2GD POWER COOLING TECHNICAL FILE FT_SVEX2GD
- 

II 2G Ex h IIC T4 Gb
II 2D Ex h IIIC T135°C Db
Tamb=-20 +40 °C
- [6] Richiedente / *Applicant:* **MOTIVE S.r.l.**
Via Le Ghiselle 20
IT - 25014 CASTENEDOLO, BS
- [7] Costruttore / *Manufacturer:* **MOTIVE S.r.l.**
Via Le Ghiselle 20
IT - 25014 CASTENEDOLO, BS
- [8] Il TÜV Italia, organismo notificato n° 0948 in conformità Direttiva 2014/34/UE del Consiglio dell'Unione Europea del 26 Febbraio 2014, avvisa il richiedente di aver ricevuto il fascicolo tecnico relativo all'apparecchiatura o sistema di protezione sopra citato in accordo alla procedura definita all'articolo 13 paragrafo 1-b-ii della Direttiva 2014/34/UE.
TÜV Italia, notified body n° 0948 in accordance with the Council Directive 2014/34/EU of 26 February 2014, notifies to the applicant to have received the technical file relates to the equipment or protective system above mentioned according to procedure defined to Article 13 paragraph 1-b-ii of the Directive 2014/34/EU.

Data prima emissione / First issue date: 29/10/2021

Data emissione / Issue date: 29/10/2021

Data scadenza / Expiry date: 28/10/2031

TÜV ITALIA Srl
Organismo Notificato No. 0948
Notified Body, No. 0948



PRD N° 081B

Membro degli Accordi di Mutuo Riconoscimento
EA, IAF e ILAC
Signatory of EA, IAF and ILAC Mutual
Recognition Agreements



Questa dichiarazione può essere riprodotta solo integralmente e senza alcuna variazione.
This declaration may only be reproduced in its entirety and without any change.



Motive s.r.l.
Via Le Ghiselle, 20
25014 Castenedolo (BS)
Tel.: +39 030 2677087
Fax: +39 030 2677125
motive@motive.it
www.motive.it

Declaration of UK Conformity

Motive srl based in Castenedolo (BS) - Italy

declares as manufacturer, under its own exclusive responsibility, that its range of

Three phase power cooling fans of the series "SV Ex"

complies with the following directives and standards:

- Directive **UKSI 2016:1107** as amended by **2019:696**: concerning "equipment and Protective systems intended for use in Potentially Explosive Atmospheres"

Marking:



II 2G Ex h IIC T4 Gb
II 2D Ex h IIIC T135°C Db
Tamb=-20 +40 °C

Voluntary type examination certificate number TÜV BABT 23 UKEX UKEX000022 i01AR
(edit by TÜV SÜD BABT, UK Approved Body Number 0168):

as in accordance to the European Standards:

- **BS EN IEC 60034-5:2020** Rotating electrical machines – Part 5: Degrees of protection provided by the integral design of rotating electrical machines (IP code) – Classification Internal methods Tests not related to standards, developed by laboratory or under client's specification
- **BS EN IEC 60079-0:2018** Explosive atmospheres – Part 0: Equipment – General requirements
- **BS EN 14986:2017** Design of fans working in potentially explosive atmospheres
- **BS EN ISO 80079-36:2016** Explosive atmospheres – Part 36: Non-electrical equipment for explosive atmospheres – Basic method and requirements
- **BS EN IEC 60079-7:2015/A1:2018** Explosive atmospheres – Part 7: Equipment protection by increased safety "e"
- **BS EN 60079-31:2014** Explosive atmospheres – Part 31: Equipment dust ignition protection by enclosure "t"
- **BS EN 60204-1:2018** Safety of machinery – Electrical equipment of machines – Part 1: General requirements

The machines are supplied without electrical connections to the control panels or any pneumatic and hydraulic supply connections.

It is therefore forbidden to use them until the plant into which they are incorporated has been declared as compliant with the provisions of the Machinery Directive **2006/42/EC** and Directive **2014/34/EU** and plant's analysis was not done as compliant with Directive **99/92/EC**.

Castenedolo, 1st January 2023
The legal Representative

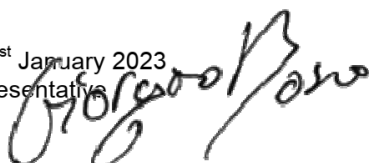



TUV SUD B A B T Unlimited, Octagon House, Concorde Way, Segensworth North, Fareham, Hants, PO15 5RL, UK

Your ref:	Our ref:	Phone-ext/E-Mail	Date	Page
722305812-FanCover / activity TUV IT	UKEX000022 i01	+39 0444 218218	09/01/2023	1 of 1

MOTIVE S.r.l.
Via Le Ghiselle, 20 – 25014 Castenedolo (BS) - ITALY

Dear MOTIVE S.r.l.,

Receipt and Storage of Technical Documentation

UKEX000022 i01

Equipment	Product Description	Documentation Reference
Reinforced fan cover for electric motors	SV Ex Series Ex marking: II 2G Ex h IIC T4 Gb II 2D Ex h IIIC T135°C Db	TECHNICAL FILE name: <i>Fascicolo Tecnico Servoventilazioni (incl. UKCA)_TUV IT 21 ATEX 112 AR Rev00.zip</i>
File Receipt Date	Period of Manufacture	Storage expiry date
09/01/2023	10 years	08/01/2033

This is to confirm receipt and storage of Technical Documentation for the product listed above, in accordance with the Equipment and Protective Systems intended for use in Potentially Explosive Atmospheres Regulations 2016, UKSI 2016:1107 (as amended by UKSI 2019:696).

MOTIVE S.r.l. have made available technical documentation as per the requirements of Module A, Internal Production Control as stated in Regulation 39 (1)(b)(ii)(bb). TUV SUD B A B T do not take any responsibility for the validity of the information provided within the technical file by the manufacturer on which parts of the assessment must be based upon. TUV SUD B A B T have not verified whether all documentation provided is correct and complete.

Any modification to the product affecting the safety integrity and product as indicated within the product description referenced, must be included within the technical file and updated.

The file will be held for 10 years after the expiry date, but no further products can be placed on the market after the expiry date.

MOTIVE S.r.l. have agreed to comply with the TUV SUD Testing and Certification Regulations as a contract condition (a copy which can be obtained from TUV SUD B A B T Unlimited).

Yours sincerely

TUV SUD B A B T Unlimited

Nicola Friso (Technical Certifier)

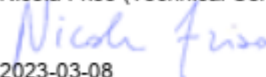
2023-03-08



Motive s.r.l.
Via Le Ghiselle, 20
25014 Castenedolo (BS)
Tel.: +39 030 2677087
Fax: +39 030 2677125
motive@motive.it
www.motive.it

Declaration of EU Conformity

Motive srl based in Castenedolo (BS) - Italy

declares as manufacturer, under its own exclusive responsibility, that its range of

asynchronous electric motors of the series "DELPHI"

complies with the following directives and standards:

- EC Directive **2014/34/EU**: concerning "equipment and Protective systems intended for use in Potentially Explosive Atmospheres"

Marking:



II 2G Ex eb IIC T4 Gb
II 2D Ex tb IIIC T135°C Db
Tamb=-20 +40 °C

Marking*:



II 2G Ex eb IIC T3 Gb
II 2D Ex tb IIIC T135°C Db
Tamb=-20 +50 °C

* Marking applicable only on DELPHI Ex IE3 motors

Certificate Number (edit by TÜV Italia, Notified Body Number 0948): TÜV IT 20 ATEX 048 X
System Certificate Number (edit by TÜV Italia, Notified Body Number 0948): TÜV IT 21 ATEX 021 Q

as in accordance to the European Standards:

- **IEC 60034-5:2020** Rotating electrical machines – Part 5: Degrees of protection provided by the integral design of rotating electrical machines (IP code) – Classification Internal methods Tests not related to standards, developed by laboratory or under client's specification
- **EN IEC 60079-0:2018** Explosive atmospheres – Part 0: Equipment – General requirements
- **EN IEC 60079-7:2015/A1:2018** Explosive atmospheres – Part 7: Equipment protection by increased safety "e"
- **EN 60079-31:2014** Explosive atmospheres – Part 31: Equipment dust ignition protection by enclosure "t"
- **IEC 60204-1:2018** Safety of machinery – Electrical equipment of machines – Part 1: General requirements

The machines are supplied without electrical connections to the control panels or any pneumatic and hydraulic supply connections.

It is therefore forbidden to use them until the plant into which they are incorporated has been declared as compliant with the provisions of the Machinery Directive **2006/42/EC** and Directive **2014/34/EU** and plant's analysis was not done as compliant with Directive **99/92/EC**.

Castenedolo, 19th March 2021
The legal Representative

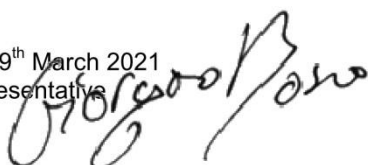



CERTIFICATE

CERTIFICAT

CERTIFICADO

СЕРТИФИКАТ

認證證書

CERTIFICATE

ZERTIFIKAT

- [1] **EU-TYPE EXAMINATION CERTIFICATE**
- [2] **Equipment or Protective System intended for use in potentially explosive atmospheres Directive 2014/34/EU**
- [3] EU-Type Examination Certificate number:
TÜV IT 20 ATEX 048 X
- [4] **Equipment:** Three-phase asynchronous electric motors DELPHI series
- [5] **Manufacturer:** MOTIVE S.r.l.
- [6] **Address:** Via Le Ghiselle 20
25014 CASTENEDOLO (BS) Italia
- [7] This equipment or protective system and any acceptable variation thereto is specified in the schedule to this certificate and the documents therein referred to.
- [8] TÜV Italia, notified body no. 0948 in accordance with Article 17 of Directive 2014/34/EU of the European Parliament and of the Council, dated 26 February 2014, certifies that this product has been found to comply with the Essential Health and Safety Requirements relating to the design and construction of products intended for use in potentially explosive atmospheres given in Annex II to the Directive.
- The examination and test results are recorded in confidential report no. R 20 EX 048
- [9] Compliance with the Essential Health and Safety Requirements has been assured by compliance with:
EN IEC 60079-0:2018 EN IEC 60079-7:2015/A1:2018 EN 60079-31:2014
- [10] If the sign "X" is placed after the certificate number, it indicates that the equipment or protective system is subject to special conditions for safe use specified in the schedule to this certificate.
- [11] This EU - TYPE EXAMINATION CERTIFICATE relates only to the design and construction of the specified product. Further requirements of the Directive apply to the manufacturing process and supply of this product. These are not covered by this certificate.
- [12] The marking of the product shall include the following:

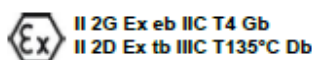

Tamb: -20° +40 °C

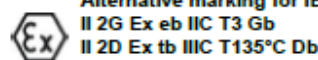

Tamb -20 +50 °C

This certificate may only be reproduced in its entirety and without any change, schedule included.

Issue date: 17th February 2021



PRD N° 081B

Membro degli Accordi di Mutuo Riconoscimento
EA, IAF e ILAC
Signatory of EA, IAF and ILAC Mutual
Recognition Agreements



TÜV Italia S.r.l.
Notified body N° 0948

Alberto Carelli
Alberto Carelli

Industry Service - Real Estate & Infrastructure
Managing Director

TÜV Italia has been authorized by Italian government to operate as notified body for the certification of equipment or protective system intended for use in potentially explosive atmospheres. This document is not valid without official signature and logo. The internal reference code is 722228711.

page 1 of 7

PEX-01-M002_r07 del 29/03/2018



Motive s.r.l.
Via Le Ghiselle, 20
25014 Castenedolo (BS)
Tel.: +39 030 2677087
Fax: +39 030 2677125
motive@motive.it
www.motive.it

Declaration of UK Conformity

Motive srl based in Castenedolo (BS) - Italy

declares as manufacturer, under its own exclusive responsibility, that its range of

asynchronous electric motors of the series "DELPHI"

complies with the following directives and standards:

- Directive UKSI 2016:1107 as amended by 2019:696: concerning "equipment and Protective systems intended for use in Potentially Explosive Atmospheres"

Marking:



II 2G Ex eb IIC T4 Gb
II 2D Ex tb IIIC T135°C Db
Tamb=-20 +40 °C

Marking*:



II 2G Ex eb IIC T3 Gb
II 2D Ex tb IIIC T135°C Db
Tamb=-20 +50 °C

* Marking applicable only on DELPHI Ex IE3 motors

UK Type Examination Certificate (issued by TUV SUD BABT, Approved Body Number 0168):
TUV SUD 23 UKEX 000024 X

Quality Assurance Certificate (ATEX QAN issued by TUV ITALIA, Notified Body Number 0948):
TUV IT 21 ATEX 021 Q

as in accordance to the Designated Standards:

- BS EN IEC 60034-5:2020 Rotating electrical machines – Part 5: Degrees of protection provided by the integral design of rotating electrical machines (IP code) – Classification Internal methods Tests not related to standards, developed by laboratory or under client's specification
- BS EN IEC 60079-0:2018 Explosive atmospheres – Part 0: Equipment – General requirements
- BS EN IEC 60079-7:2015/A1:2018 Explosive atmospheres – Part 7: Equipment protection by increased safety "e"
- BS EN 60079-31:2014 Explosive atmospheres – Part 31: Equipment dust ignition protection by enclosure "t"
- BS EN 60204-1:2018 Safety of machinery – Electrical equipment of machines – Part 1: General requirements

Castenedolo, 1st January 2023
The legal Representative

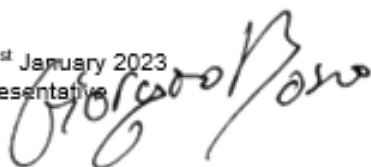



1 UK Type Examination Certificate

2 Product or Protective System Intended for use in Potentially Explosive Atmospheres
UKSI 2016:1107 (as amended) – Schedule 3A, Part 1

3 Type Examination TUV SUD 23 UKEX 000024 X Issue: i01

Certificate No.:

4 Product Three-phase asynchronous electric motors DELPHI series

5 Manufacturer MOTIVE S.r.l.

6 Address Via Le Ghiselle, 20 – 25014 Castenedolo (BS) - ITALY

7 This product and any acceptable variation thereto is specified in the schedule to this certificate and the documents therein referred to.

8 TUV SUD BABT Unlimited, Approved Body no.0168 in accordance with Regulation 42 of the Equipment and Protective Systems Intended for use in Potentially Explosive Atmospheres Regulations 2016, UKSI 2016/1107 (as amended) certifies that this product has been found to comply with the Essential Health and Safety Requirements relating to the design and construction of products intended for use in potentially explosive atmospheres given in schedule 1 of the regulations.

The examination and test results are recorded in confidential report no. TR-722305814 (Delphi)

9 Compliance with the Essential Health and Safety Requirements has been assured by compliance with:

EN IEC 60079-0:2018 EN IEC 60079-7:2015/A1:2018 EN 60079-31:2014

Except in respect of those requirements listed at section 18 of the schedule to this certificate.

10 If the sign "X" is placed after the certificate number, it indicates that the product is subject to specific conditions of use specified in the schedule to this certificate.

11 This TYPE EXAMINATION CERTIFICATE relates only to the design and construction of the specified product. Further requirements of the Regulations apply to the manufacturing process and supply of this product. These are not covered by this certificate.

12 The marking of this product shall include the following:



II 2G Ex eb IIC T4 Gb
II 2D Ex tb IIIC T135°C Db

Tamb: -20° +40 °C



Alternative marking for IE3 series

II 2G Ex eb IIC T3 Gb
II 2D Ex tb IIIC T135°C Db

Tamb -20 +50 °C

This certificate and its schedules may only be reproduced in its entirety and without change.

Issue Date: 15/03/2023

TUV SUD BABT Unlimited
Approved Body N° 0168



Frank Zhu

TUV SUD BABT has been authorized by the UK government to operate as an Approved Body for the certification of equipment or protective system intended for use in potentially explosive atmospheres. This document is not valid without official signature and logo.

This certificate has been issued in accordance with the TÜV SÜD Testing and Certification Regulations
TUV SUD BABT Unlimited • Octagon House • Concorde Way • Fareham • Hampshire • PO15 5RL • United Kingdom



NOTIFICATION

[1] **PRODUCT QUALITY ASSURANCE NOTIFICATION**

[2] **Equipment or Protective System or Component intended for use
in potentially explosive atmospheres
Directive 2014/34/EU**

[3] Notification number:

TÜV IT 21 ATEX 021 Q

[4] Equipment or Component as listed: Electric Motor, Frequency Converter

Protection concepts: "e" and "t"

[5] Manufacturer: MOTIVE S.r.l.
Via Le Ghiselle, 20
I-25014 Castenedolo (BS) - ITALIA

[6] Sites audited: identical

[7] TÜV Italia, notified body no. 0948 in accordance with the Council Directive 2014/34/EU of 26 February 2014, notifies that the manufacturer has a product quality assurance system which complies to Annex VII of the Directive.

[8] This notification is based on audit report no. R 21 EX 015 issued on 02.03.2021

This notification can be withdrawn if the manufacturer no longer satisfies the requirement of Annex VII.

Results of periodical re-assessment of the quality system are a part of this notification.

[9] This notification is valid until <01.03.2024> and can be withdrawn if the Manufacturer does not satisfy the production quality assurance re-assessment.

[10] According to Article 16 paragraph 3 of the Directive 2014/34/EU the CE marking shall be followed by the identification no. 0948 identifying the notified body involved in the production control stage.

This notification may only be reproduced in its entirety and without any change.

First issue date: 26.03.2021
Issue date: 26.03.2021



PRD N° 081B

Membro degli Accordi di Mutuo Riconoscimento
EA, IAF e ILAC
Signatory of EA, IAF and ILAC Mutual
Recognition Agreements



TÜV Italia S.r.l.
Notified Body N° 0948

Alberto Carelli

**Industry Service - Real Estate & Infrastructure
Managing Director**

TÜV Italia has been authorized by Italian government to operate as notified body for the certification of equipment or protective system intended for use in potentially explosive atmospheres. This document is not valid without official signature and logo. The internal reference code is 72223318

page 1 of 2

PEX-01-M011_r10 del 07/08/2018

TÜV Italia • Gruppo TÜV SÜD • Via Carducci 125, Pal. 23 • 20099 Sesto San Giovanni (MI) • Italia • www.tuvsud.com/it



CERTIFICAT

CERTIFICADO

СЕРТИФИКАТ

認證證書

CERTIFICATE

ZERTIFIKAT